

OVERVIEW OF UK'S NUCLEAR PHYSICS PROGRAMME

Dave Ireland (Glasgow)

with contributions from

Dan Watts (York)

Paul Stevenson (Surrey)

$$\frac{\partial^2 u}{\partial t^2} = c^2 \frac{\partial^2 u}{\partial x^2}$$

$$\frac{df}{dt} = \lim_{h \rightarrow 0} \frac{f(t+h) - f(t)}{h}$$

MAJOR FACILITIES FOR NUCLEAR PHYSICS RESEARCH

World
Context



 Existing

 Under construction

NSAC Long Range Plan 2023

– Science Questions

- How do quarks and gluons make up protons, neutrons, and, ultimately, atomic nuclei?
- How do the rich patterns observed in the structure and reactions of nuclei emerge from the interactions between neutrons and protons?
- What are the nuclear processes that drive the birth, life, and death of stars?
- How do we use atomic nuclei to uncover physics beyond the Standard Model?

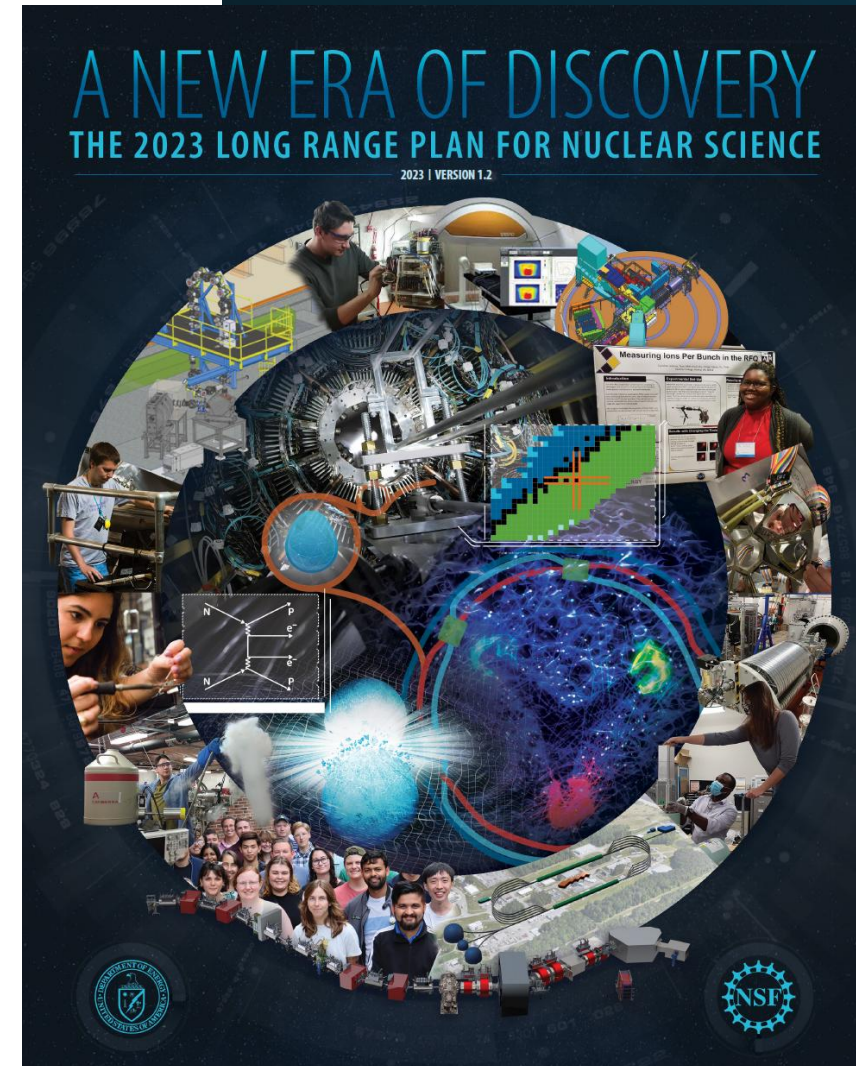

NuPECC Long Range Plan 2024

- How does the majority of the visible mass of the universe emerge from the almost massless quarks?
- What are the properties of the quark-gluon plasma, what is the qualitatively novel state of nuclear matter at extreme conditions of temperature and density?
- How do nuclei and nuclear matter emerge from the underlying fundamental interactions?
- What shapes can nuclei take, how do nuclear shells evolve, and what role do nuclear correlations play?
- What are the limits of the existence of nuclei, and what phenomena arise from open quantum systems?
- What are the mechanisms behind nuclear reactions and nuclear fission?
- How can we better understand the synthesis of heavy elements and the chemical evolution of the visible universe?
- What is the role of the strong interaction in stellar objects?
- What can nuclear physics teach us about the limits of the Standard Model of Particle Physics?
- How might nuclear physics strengthen its role in society's sustainable development?



UK Nuclear Physics Community

Topic areas:

- Nuclear Structure and Reactions
- Nuclear Astrophysics
- Hadron Physics

Fundamental science questions

- Where are the limits of nuclear existence?
 - How does nuclear structure evolve in exotic nuclear systems, what mechanisms drive new structural phenomena?
 - How well are nuclei described in terms of the underlying fundamental interactions based on QCD?
-
- What are the nuclear processes responsible for the synthesis of the elements in various astrophysical sites/conditions?
-
- Can the dynamics of QCD fully explain hadron (and exotic hadron) properties e.g. structure, confinement, mass, excitation, spin,..?
 - Is there evidence of gluon saturation in high-energy nuclear collisions?
 - What is the nature of the quark-gluon plasma, and how does it emerge from fundamental interactions?
 - How do hadron and nuclear properties relate to neutron stars, black hole formation or matter during the early evolution of the Universe?

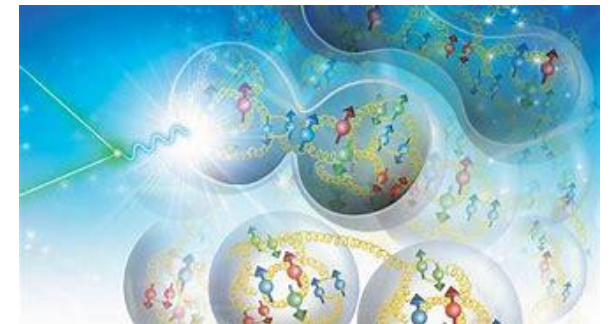
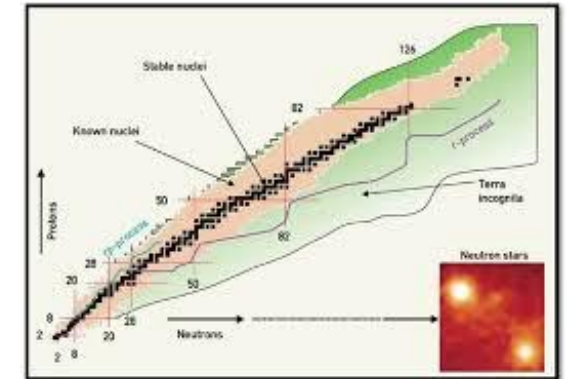

Nuclear Physics in the UK

- 12 Universities
- 1 national laboratory
- 1 accelerator facility (MC40)

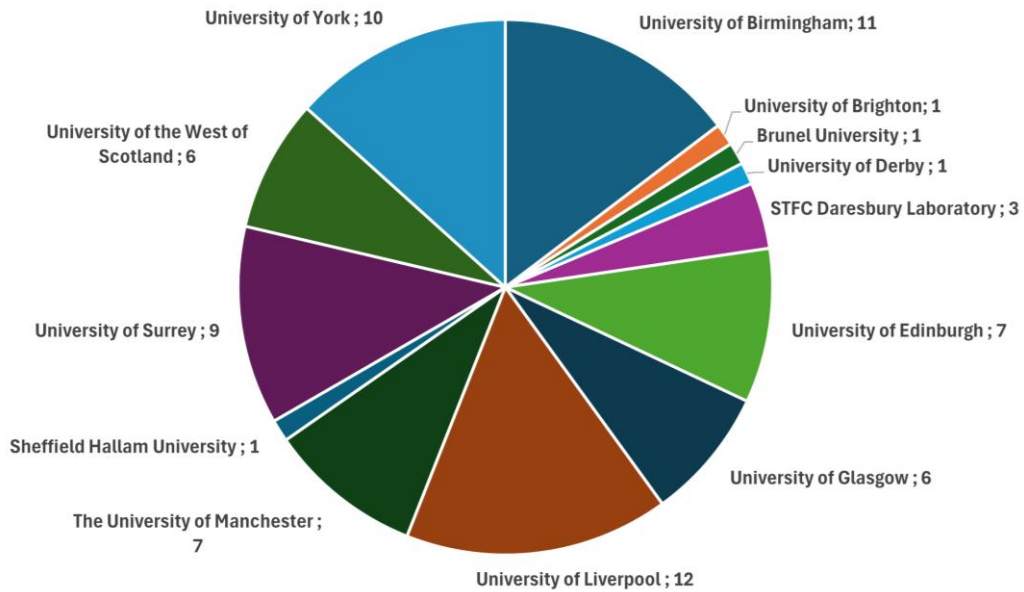

Number of NP academics per institute (75 total)



Scotland
 UWS (NS/NA)
 Glasgow (HP)
 Edinburgh (NS/NA)

North of England
 Liverpool (NS/NA/HP)
 Manchester (NS/NA/HT)
 Sheffield (HP)
 York (NS/NA/HP/NT)

Midlands
 Birmingham (NS/NA/HP)
 Derby (HP)

Southern England
 Surrey (NS/NA/NT)
 Brighton (NS/NA)
 Brunel (HP)

Daresbury lab (NS/NA/HP)

MC40 proton/neutron beam facility (NS/NA)

Nuclear PDRA in the UK by institute (source NPAP24)

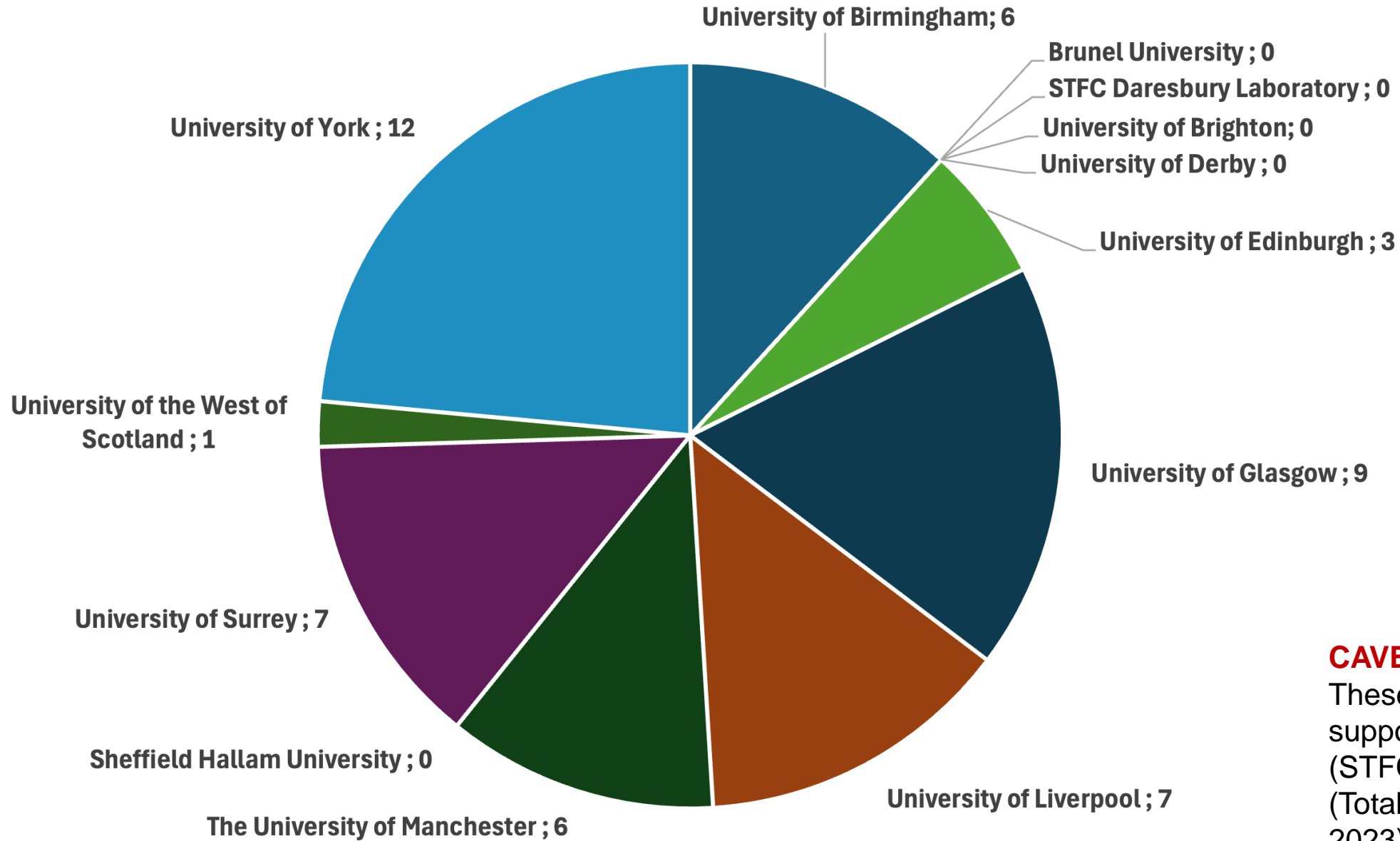

CAVEATS:

These show **51** PDRA supported for both pure science (STFC) and industry projects (Total STFC CG PDRA 27 in 2023)

Nuclear PhD students in the UK by institute (source NPAP24)

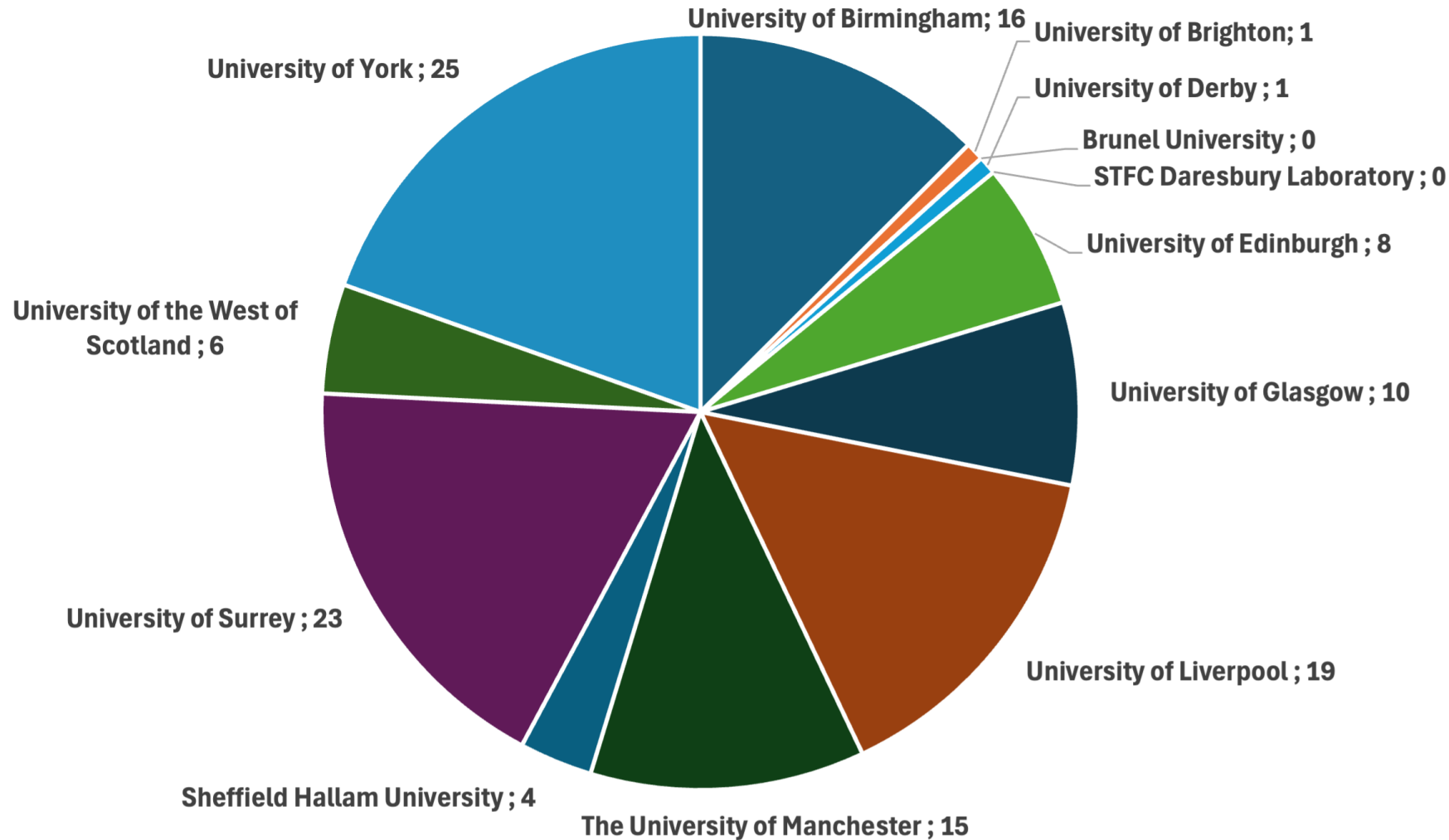

CAVEATS:

These show **128** PhD supported by STFC **as well as** industry projects, self-funding students

Nuclear technicians/engineers in the UK by institute (source NPAP24)

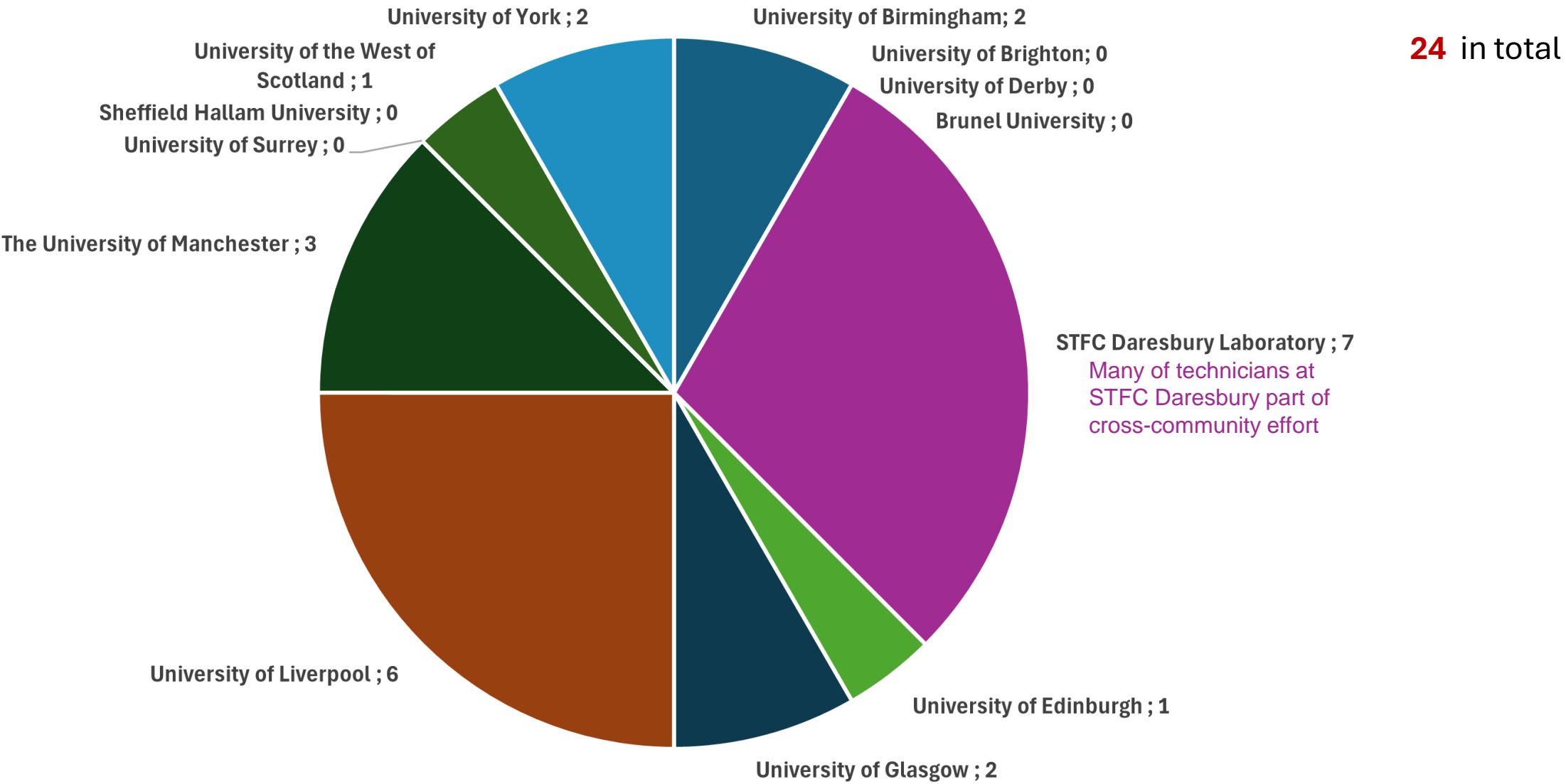

Context within Europe

- UK NP community is smaller than comparable economies in mainland Europe
- Relative contribution of nuclear theory (~5% of academics) is smaller than in Europe, US and Asia – current priority to increase theory support

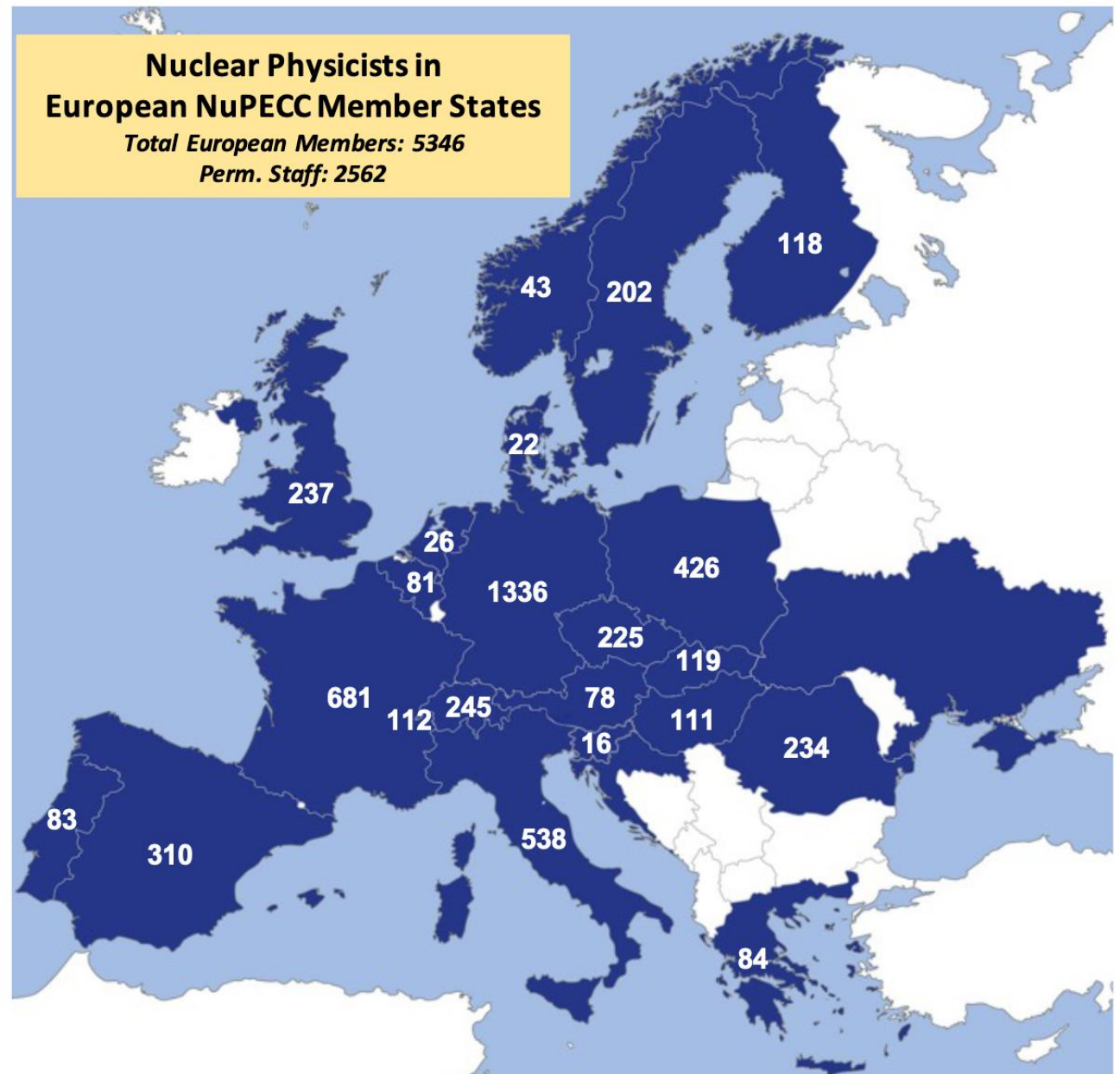

Nuclear physicists in the European NuPECC Member countries and the Associated Member CERN (source: NuPECC survey 2021 and 2023).

(Indicative) Facility use

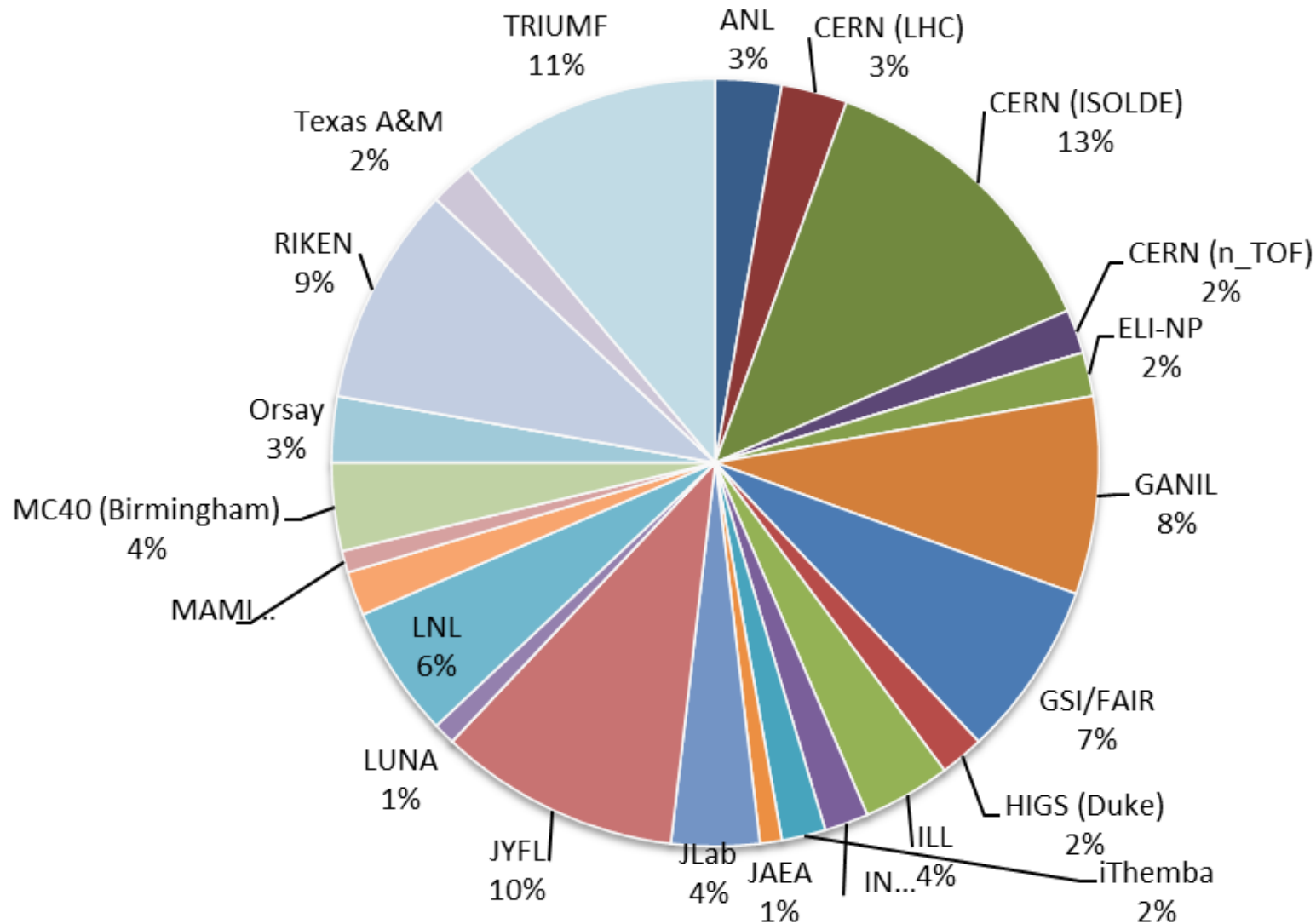

CAVEATS:

Only shows the breadth of engagement of UK community

Shows facilities mentioned in STFC Consolidated Grant (CG) research themes in 2023

Nuclear structure/astro – programmes typically based on a number of facilities

Hadron programmes typically focus on a single facility

Facility map and recent UK leadership roles

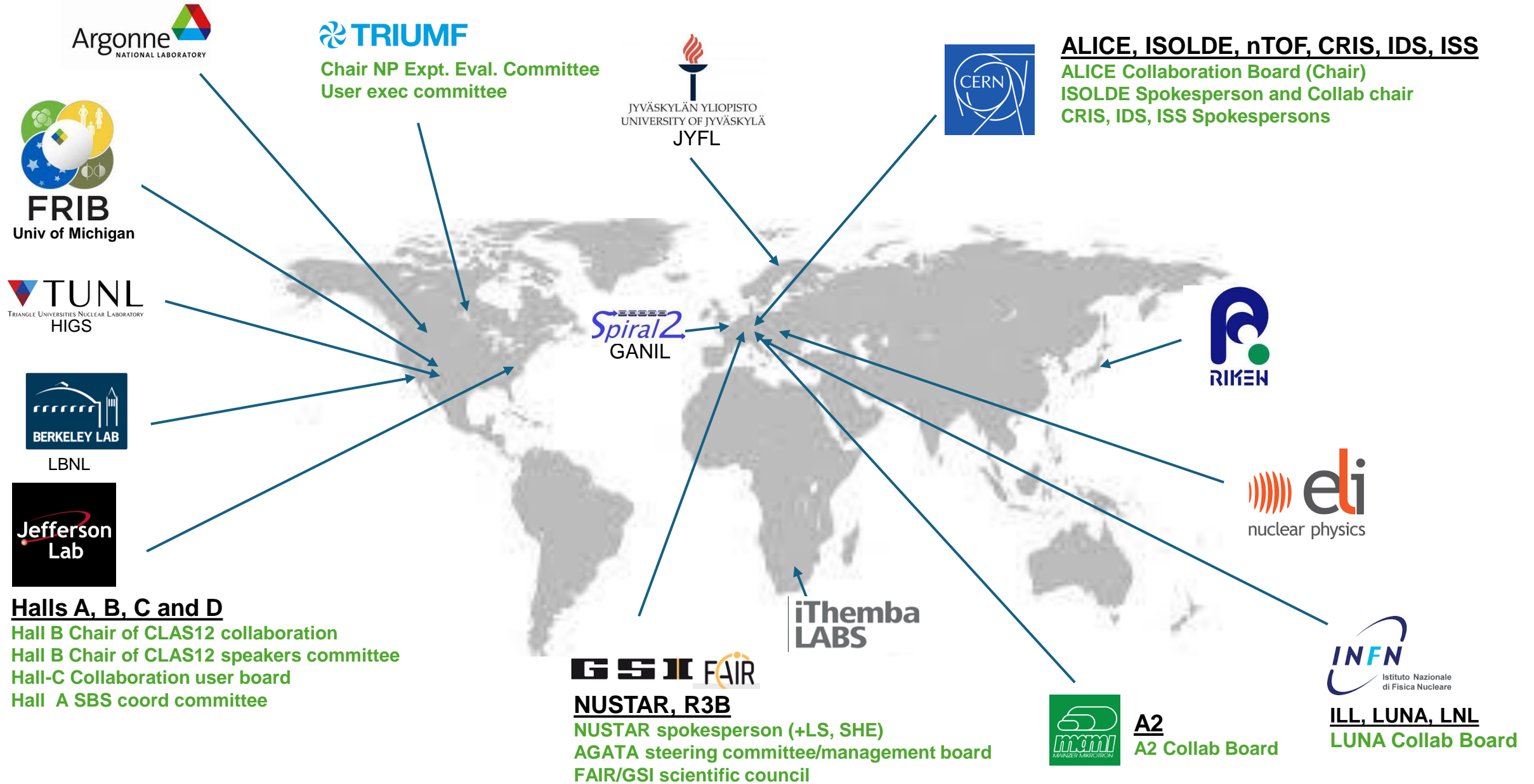

Recent infrastructure leadership

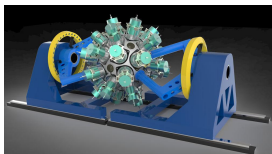

FAUST



DEMAND neutron array
(Also for FRIB)

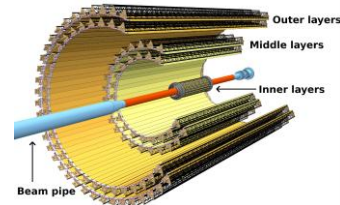

ALICE inner tracker



ALICE central trigger system

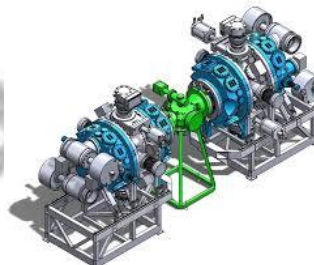

ISOL SRS

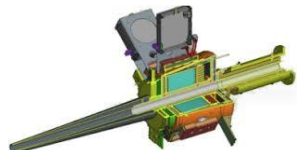

Forward tagger (Hall B)

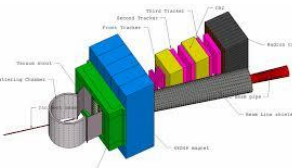

SBB spectrometer
(Hall A)

Neutral Kaon beam
Facility (Hall D)

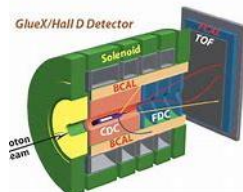

AGATA

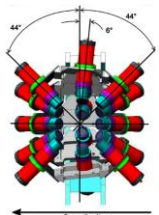

DESPEC/
HISPEC

AIDA



R3B - TRT

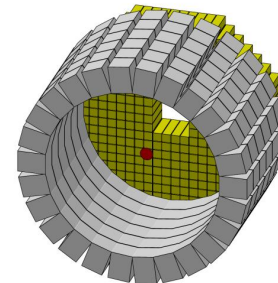
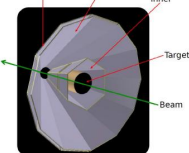

HYPATIA array
 γ RIBF

Projects funded in most recent STFC Projects (PPRP) round in 2023

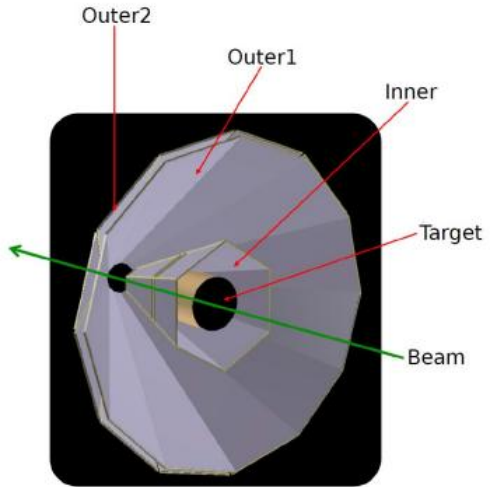

R3B-TRT; 2.9M

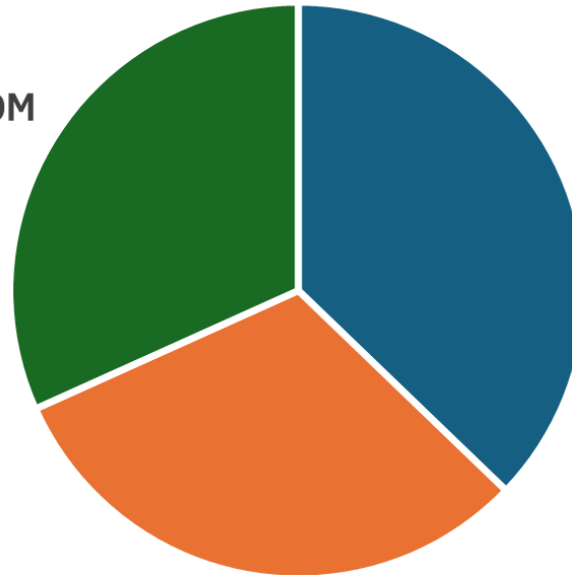

FAUST, 3.4M

gRIBF, 2.84M

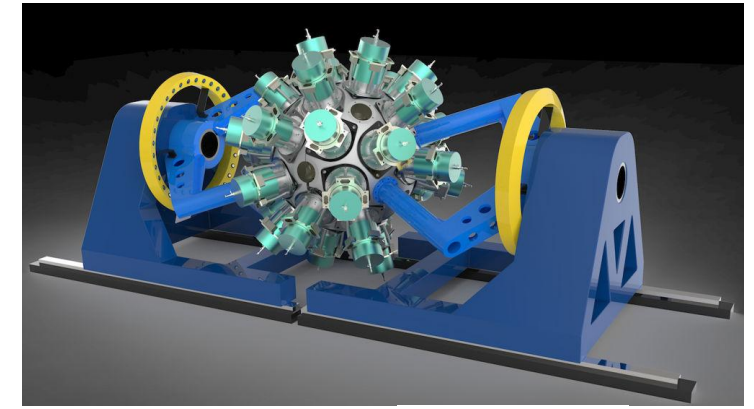
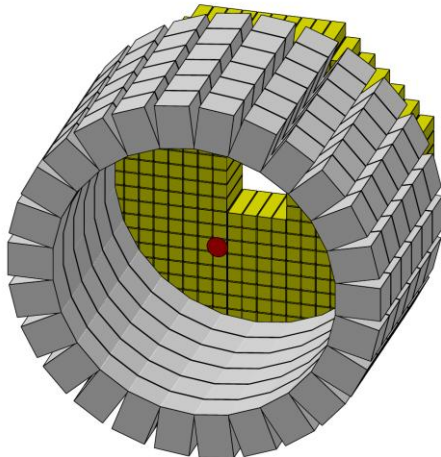

FRIB
Univ of Michigan

Previous rounds saw significant investment in ALICE@LHC, SRS@ISOLDE, JLab

UKRI infrastructures project – Electron ion collider (Brookhaven)

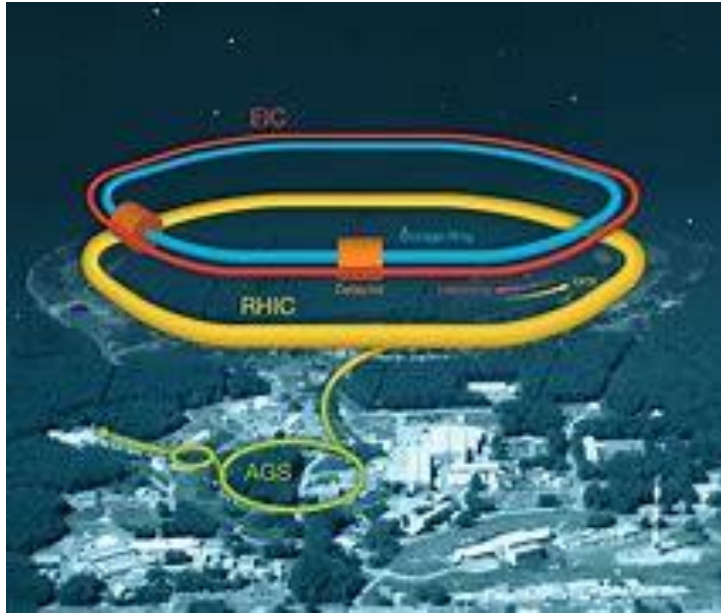

- Image the gluonic contribution of matter, nature of strong force, mass generation, hadron spectroscopy, ...
- UK contribution recently funded by UKRI infrastructure fund
Seven universities and two national laboratories (£58M)
- Contributions to ePIC detector :
 - SVT (MAPS)
 - Electron tagger (TIMEPIX)
 - AI-guided Calorimetry
- Also – collaboration in delivery of EIC accelerator infrastructure
- Expected to be online in 2032

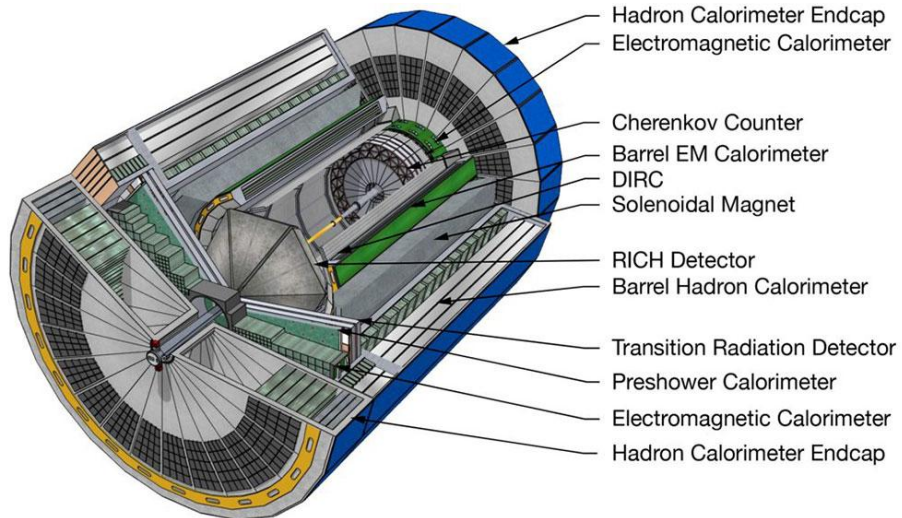

(Some of the) Future projects in the UK roadmap

AGATA upgrade – Progress from 3π to 4π spectrometer

ALICE upgrade - Collaboration proposes a novel detector - ALICE3 - with high readout rate, superb pointing resolution and excellent tracking and particle ID using advanced silicon (MAPS) detectors. LHC Runs 5,6 (2035).

Legend 1000 – Neutrinoless double β decay; isotopically enriched ^{76}Ge

E1-M2 Mössbauer – Nuclear CP violating moment in odd mass pear shaped nucleus.

GSI/FAIR upgrade - New storage ring taking beams directly from the new SIS100 - SuperFRS accelerator/fragment separator. Increased beam intensities, transmission \rightarrow new detector infrastructure

JLAB upgrade – Upgrade from 12 GeV to 22 GeV proposed. Enhanced capabilities for 3D imaging of nucleon; exceed J/psi threshold, new meson structure programmes, new possibilities for neutral Kaon beam

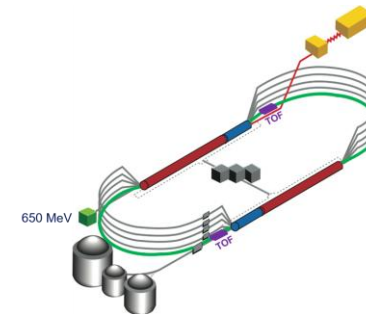
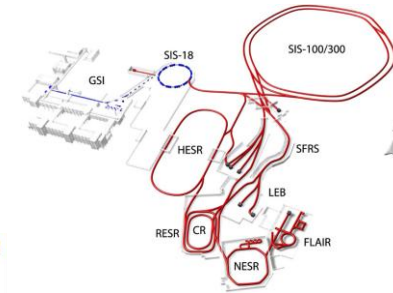
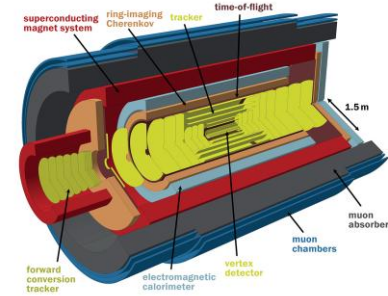
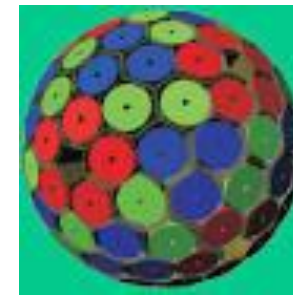

UK NP publications in refereed journals

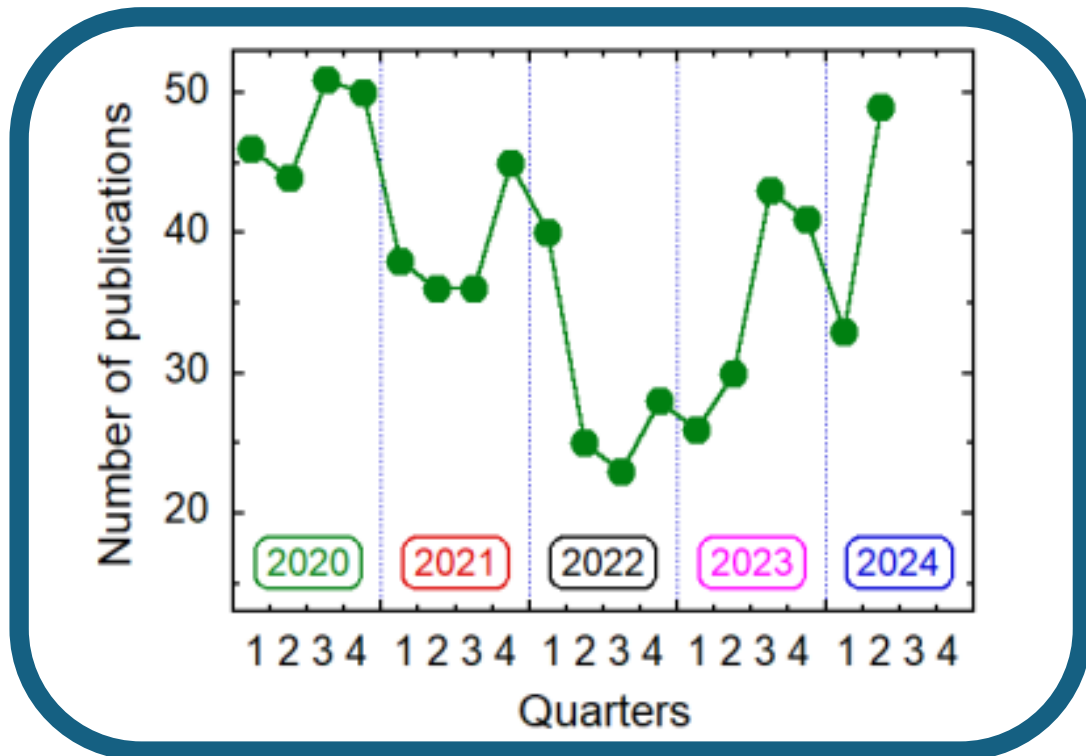

2020-2024: Nature Journals (17),
Phys. Rev. Lett.(105)
Phys. Lett. B (64)

For a list of recent research highlights from UK NP - see backup slides



OPEN
Charge radii of exotic potassium isotopes challenge nuclear theory and the magic character of $N = 32$



Article

The baryon density of the Universe from an improved rate of deuterium burning

<https://doi.org/10.1038/s41586-020-2878-4>
Received: 7 May 2020
Accepted: 16 September 2020
Published online: 11 November 2020
Check for updates

V. Mossa¹, K. Stöckle^{1,2}, F. Cavanna^{1,3,4}, F. Ferraro⁵, M. Aliotta⁶, F. Barile⁶, D. Bemmerer⁷, A. Best⁸, A. Boeltz^{9,10}, C. Broggini¹¹, C. G. Bruno¹², A. Cacciari¹³, T. Chillery¹⁴, G. F. Ciavino¹⁵, P. Corvisiero¹⁶, L. Csodreke¹⁷, T. Davinson¹⁸, R. Depalo¹⁹, A. Di Leva²⁰, Z. Elekes²¹, E. M. Fiore²², A. Formicola²³, Zs. Fülep²⁴, G. Gervino²⁵, A. Guglielmetti²⁶, C. Gustavino²⁷, G. Gyürky²⁸, G. Imbriani²⁹, M. Junker³⁰, A. Kievsky³¹, J. Kochanek³², M. Lugaro³³, L. E. Marcucci³⁴, G. Mangano³⁵, P. Marigo³⁶, E. Masha³⁷, R. Menegazzo³⁸, F. R. Pantaleo³⁹, V. Patricchio⁴⁰, R. Perrino⁴¹, D. Piatti⁴², O. Pisanti⁴³, P. Prati⁴⁴, L. Schiavulli⁴⁵, O. Straniero⁴⁶, T. Szücs⁴⁷, M. P. Takács⁴⁸, D. Trezzi⁴⁹, M. Viviani⁵⁰ & S. Zavattarelli⁵¹

nature physics

Article <https://doi.org/10.1038/s41586-023-02296-w>

Precision spectroscopy and laser-cooling scheme of a radium-containing molecule

Received: 2 March 2023
Accepted: 19 October 2023
Published online: 9 January 2024
Check for updates

S. M. Udrescu¹, S. G. Wilkins², A. A. Breier³, M. Athanasiadis-Kaklamaniaki⁴, R. F. Garcia Ruiz⁵, M. Au^{6,7}, I. Beloev⁸, R. Berger⁹, M. L. Bissell¹⁰, C. L. Binnsley¹¹, A. J. Brinson¹², K. Chrysalidis¹³, T. E. Cocolios¹⁴, R. P. de Groote¹⁵, A. Dorne¹⁶, K. T. Flanagan¹⁷, S. Franchou¹⁸, K. Gault¹⁹, S. Geldhof²⁰, T. F. Giesen²¹, D. Hanstorp²², R. Heinke²³, A. Kozlov²⁴, S. Kujala²⁵, L. Lalanne²⁶, G. Neyens²⁷, M. Nicholas²⁸, H. A. Perrett²⁹, J. R. Reilly³⁰, S. Rothe³¹, B. van den Borne³², A. R. Vernon³³, Q. Wang³⁴, J. Wessolek³⁵, X. F. Yang³⁶ & C. Zülch³⁷

Article

Direct observation of the dead-cone effect in quantum chromodynamics

<https://doi.org/10.1103/PhysRevLett.130.211902> ALICE Collaboration¹
Received: 29 June 2021
Accepted: 21 February 2022
Published online: 18 May 2022
Open access

In particle collider experiments, elementary particle interactions with large momentum transfer produce quarks and gluons (known as partons) whose evolution is governed by the strong force, as described by the theory of quantum chromodynamics (QCD). These partons subsequently emit further partons in a

PHYSICAL REVIEW LETTERS 130, 211902 (2023)

First CLAS12 Measurement of Deeply Virtual Compton Scattering Beam-Spin Asymmetries in the Extended Valence Region

G. Christiaens,^{1,2} M. Defurne,^{1,3} D. Sokhan,^{1,2} P. Achenbach,³ Z. Akbar,⁴ M. J. Amarian,⁵ H. Atac,⁶ H. Avukian,⁷ C. Ayerbe Gayoso,⁸ L. Baashen,⁹ N. A. Baltzell,¹⁰ L. Bacion,¹¹ M. Bashkanov,¹² M. Battaglieri,¹³ J. Bedlinskiy,¹² B. Benkel,¹³ F. Benmokhtar,¹⁴ A. Bianconi,^{15,16} A. S. Biselli,¹⁷ M. Bondi,¹⁸ W. A. Booth,¹⁹ F. Bossi,²⁰ S. Boiarinov,²¹ G. Bourrely,²² S. Kujala,²³ L. Lalanne,²⁴ G. Neyens,²⁵ M. Nicholas,²⁶ H. A. Perrett,²⁷ J. R. Reilly,²⁸ S. Rothe,²⁹ B. van den Borne,³⁰ A. R. Vernon,³¹ Q. Wang,³² J. Wessolek,³³ X. F. Yang,³⁴ & C. Zülch³⁵



ARTICLE

Photon quantum entanglement in the MeV regime and its application in PET imaging

D. P. Watts^{1,2}, J. Bordes³, J. R. Brown⁴, A. Cherlin⁵, R. Newton⁶, J. Allison^{3,4}, M. Bashkanov⁷, N. Efthimiou⁸ & N. A. Zachariou¹

Recent (indicative) funding for UK NP outside of main grants panel

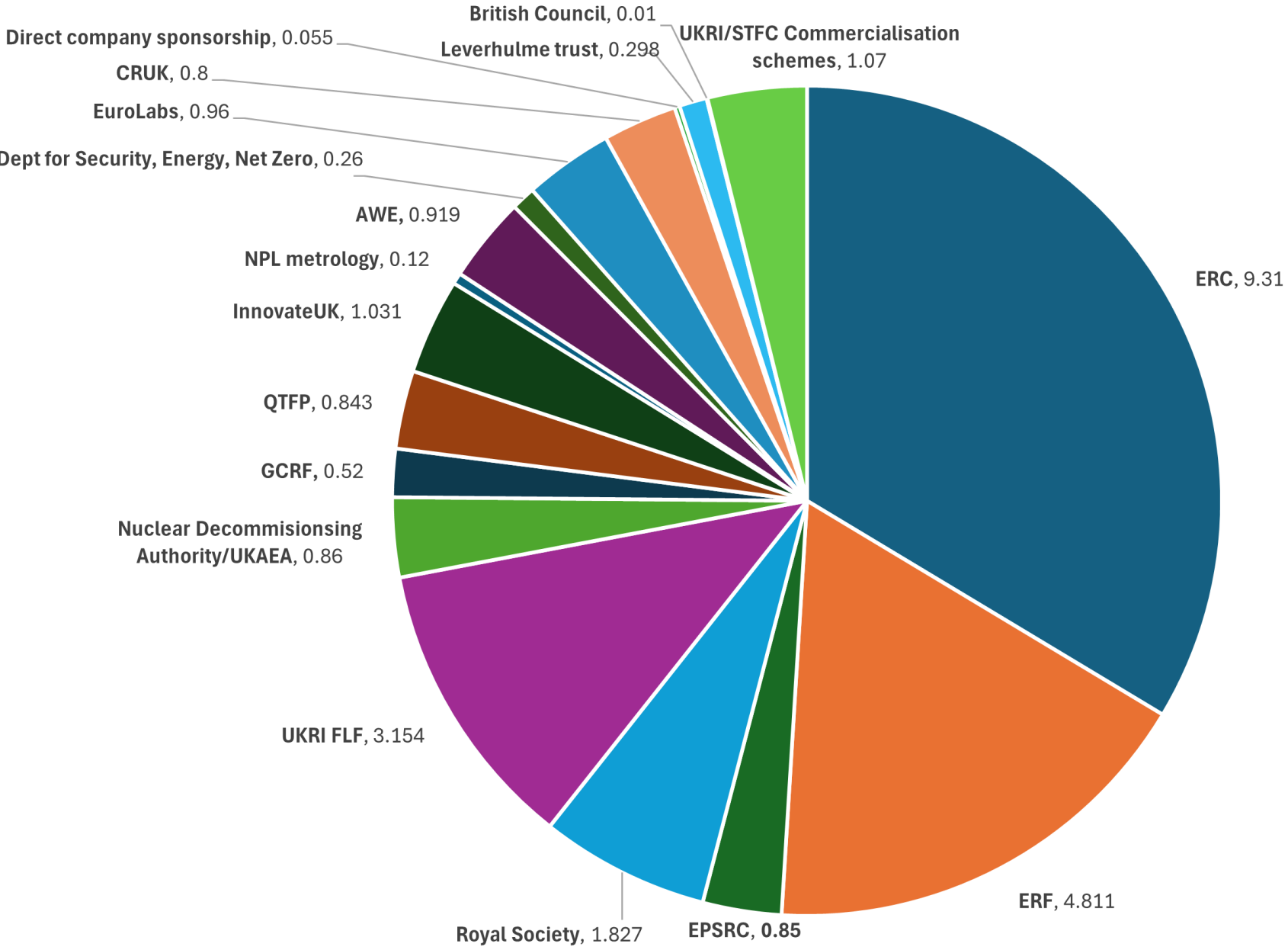

Numbers show funding awarded in £M

CAVEATS:
Responses from 9 of 12 groups
(ERF numbers from NPAP24)

(Some) recent examples of societal impact from NP

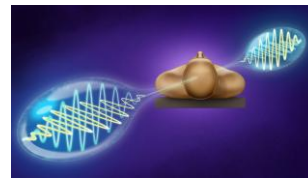

Quantum information in PET imaging – dose reduction (QTFP)

Nuclear waste management/security: LINKEOS



Oil industry, industrial imaging: AevaSpec

Radiation monitors for personnel e.g. D3S developed for Kromek (recent \$6M purchase by US authorities)



Medical isotope production using γ -beams at intensity frontier

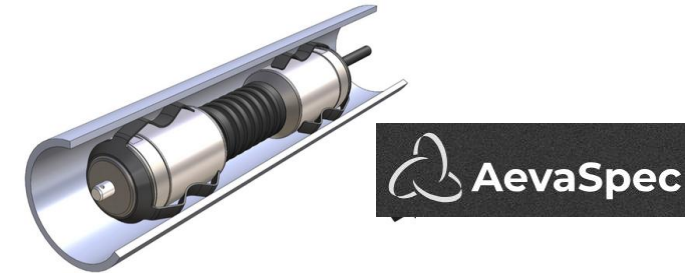

Ultra-fast rf photon detectors (with timepix) for medical imaging and quantum optics



MAPS technologies in medical physics : OPTima



AWE collaborations e.g. VENOM, a new neutron facility for nuclear research and isotopic assay

Binding blocks - One of UK's largest outreach activities reaching 1000's of school students (in-person) + online materials for educators

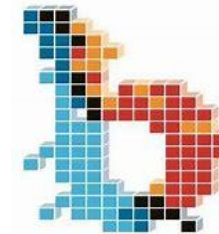

+ high-level training in nuclear physics, cutting-edge detector technologies, advanced simulation – skills sought for medical/industrial imaging, medical physics, nuclear industry, finance, ..

UK Nuclear Physics Theory

$$F = \frac{m_1 m_2}{d}$$

$$F - E + V = 2$$

$$i\hbar \frac{\partial}{\partial t} \psi = \hat{H} \psi$$

$$\phi(x) = \frac{1}{\sqrt{2\pi\sigma}} e^{-\frac{(x-\mu)^2}{2\sigma^2}}$$

$$E = mc^2$$

$$ds \geq 0$$

$$\frac{\partial^2 u}{\partial t^2} = c^2 \frac{\partial^2 u}{\partial x^2}$$

$$\frac{df}{dt} = \lim_{h \rightarrow 0} \frac{f(t+h) - f(t)}{h}$$

Nuclear Energy Density-Functional Approaches

Dobaczewski (York), Yüksel (Surrey), Stevenson (Surrey)

Ravlić, Yüksel, Nikšić & Paar, [Nature Commun. 14, 4834 \(2023\)](#)

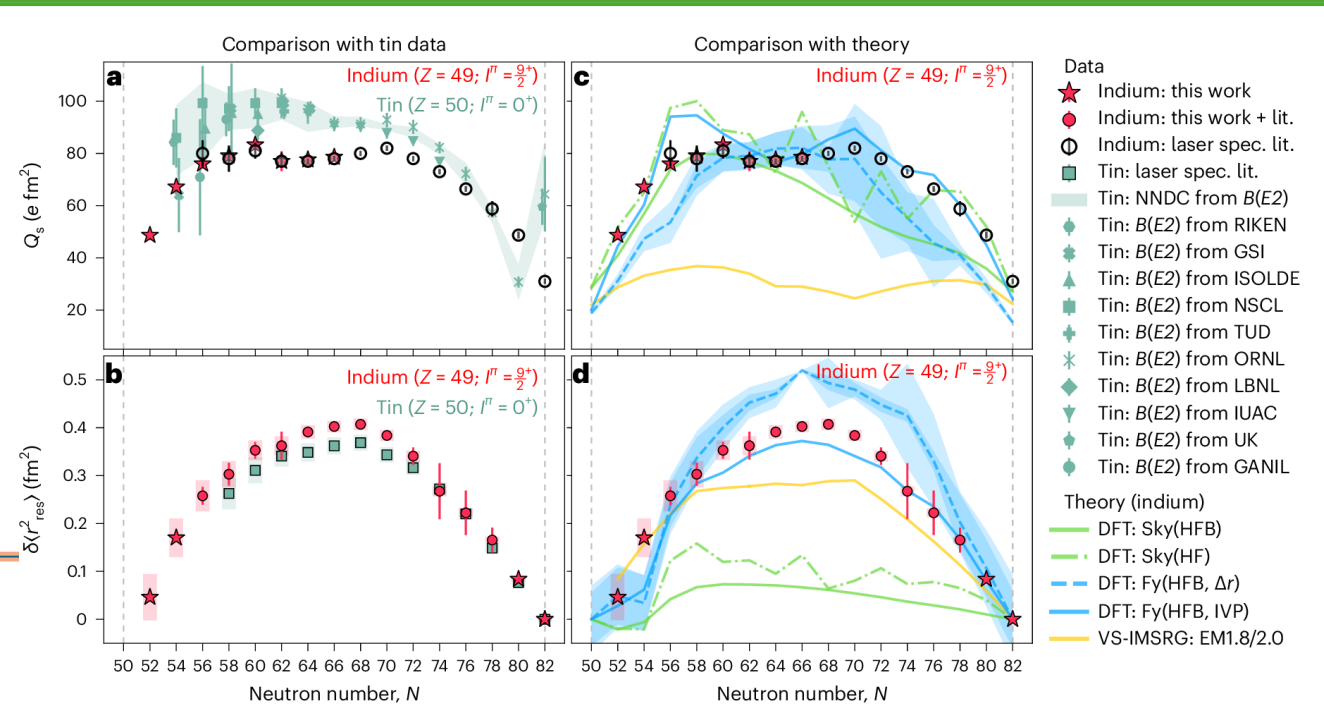
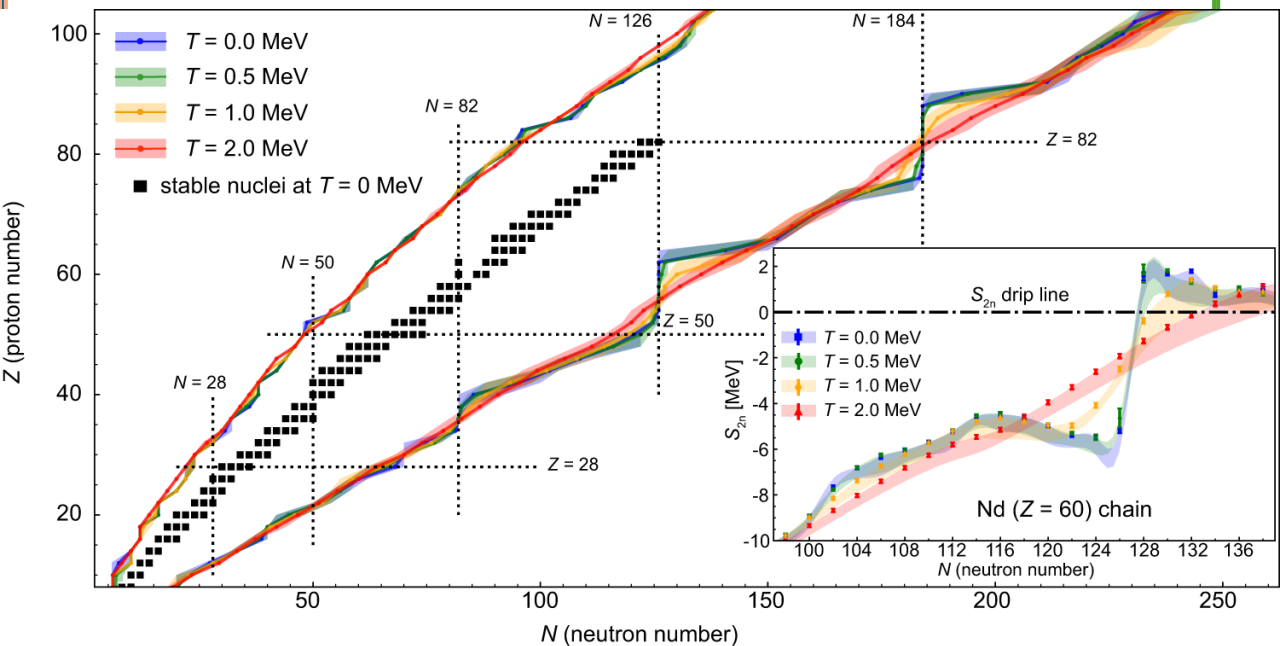

Karthein, ..., [Dobaczewski, et al. Nature Physics 20, 1719 \(2024\)](#)

see also
 Arrowsmith-Kron, ..., [Dobaczewski, ... et al., Opportunities for fundamental physics research with radioactive molecules Rep. Prog. Phys. 87 084301 \(2024\): DFT input to beyond-standard model physics](#)

Nuclear Reactions: Stevenson (Surrey), Timofeyuk (Surrey), Diaz-Torres (Surrey)

Time-dependent density-functional simulation of fusion of $^{48}\text{Ca} + ^{254}\text{Es}$ as potential reaction to create element 119. Movie @220 MeV CM energy. Stevenson, [Frontiers in Physics 10, 1019285 \(2022\)](#)

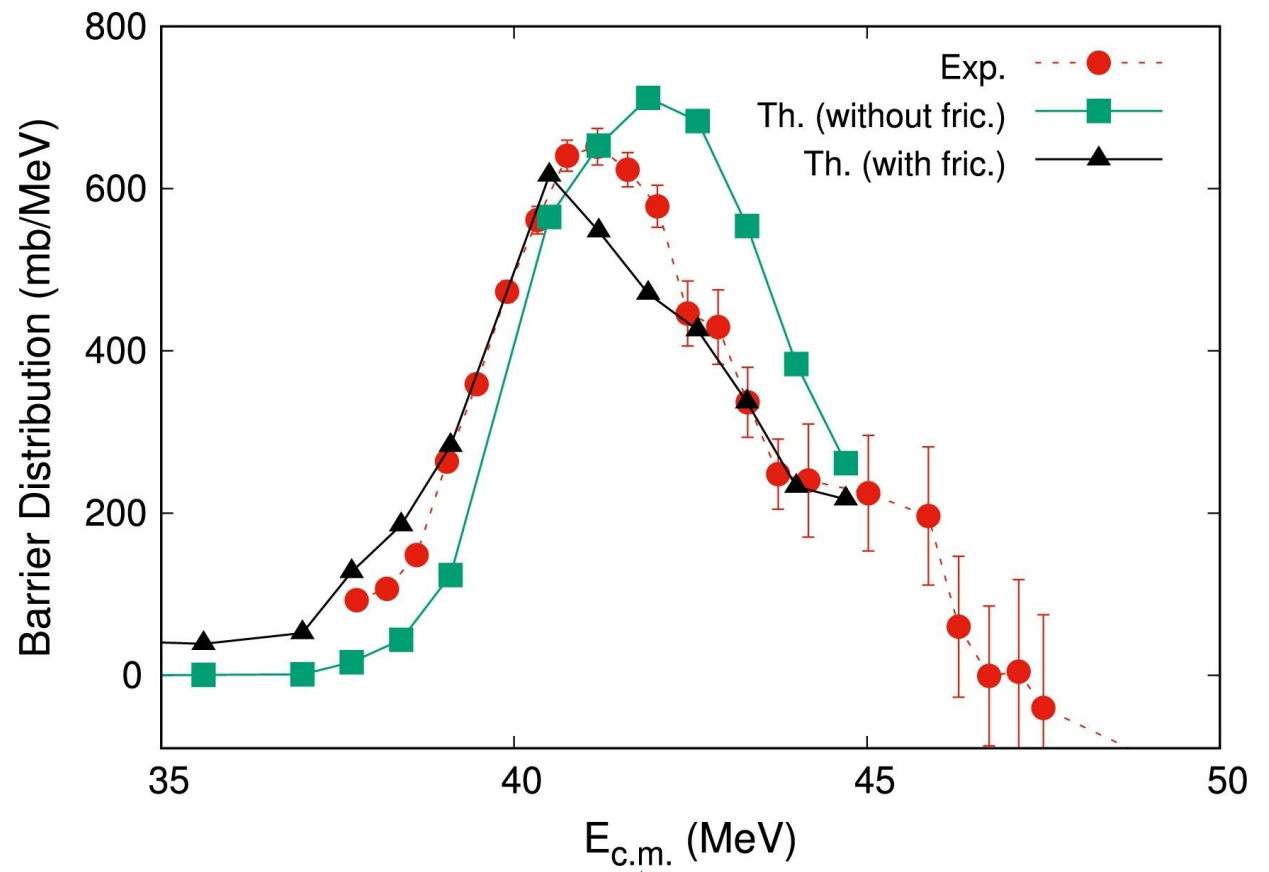
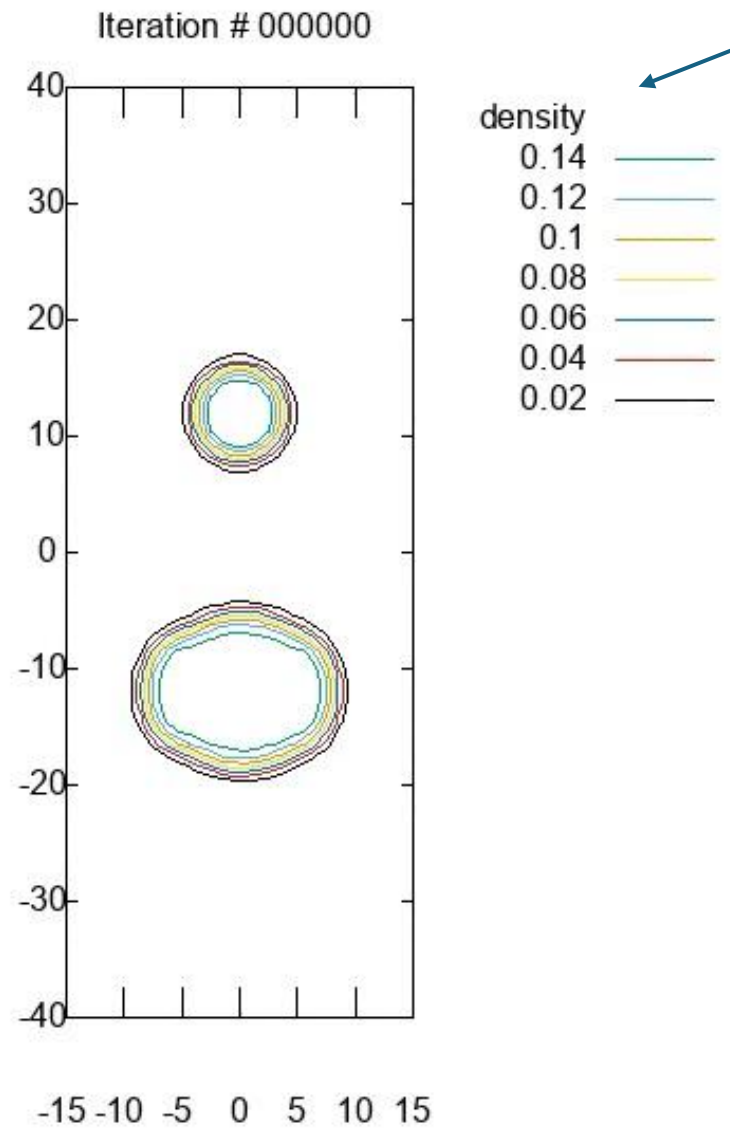

Quantum friction effects in heavy-ion collision between ^{16}O and ^{92}Zr . Lee, Stevenson, Diaz-Torres, [Phys. Lett. B 854, 138755 \(2024\)](#)

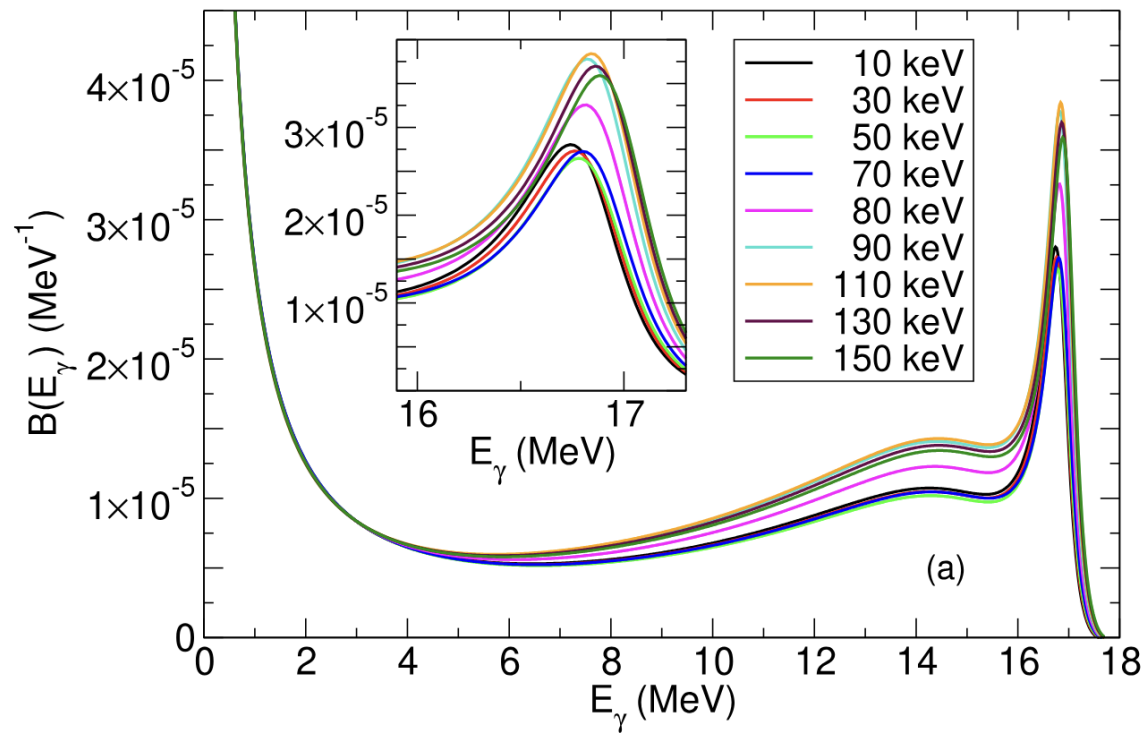

Timofeyuk, Bailey and Gilbert, Phys. Rev. C **110**, 014612 (2024)
 UKAEA collaboration on D-T fusion
 Gamma-branching ratios in D-T fusion as diagnostic

Ab-initio structure and reactions: Vorabbi (Surrey)

Vorabbi *et al.*, [Physical Review C 109, 034613 \(2024\)](#): Optical potentials derived from ab initio structure model: essentially model free from interaction to scattering data

Nuclear Reactions

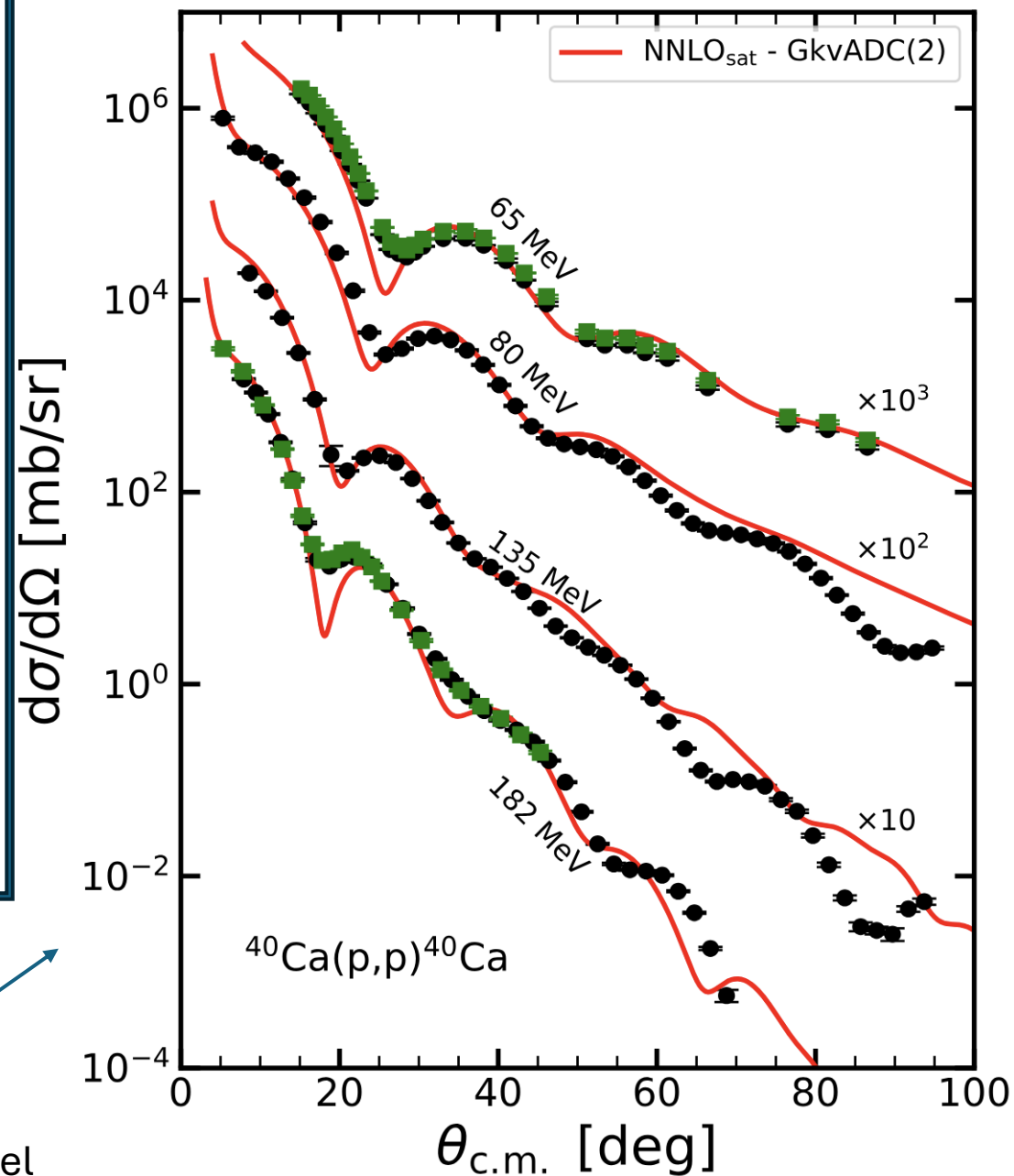

Quantum Computing for Nuclear Theory

Stevenson (Surrey)

Hobday, Stevenson & Benstead, [arXiv 2403.08625](https://arxiv.org/abs/2403.08625)
Variational algorithm to target excited states, on IBM_Nairobi quantum computer

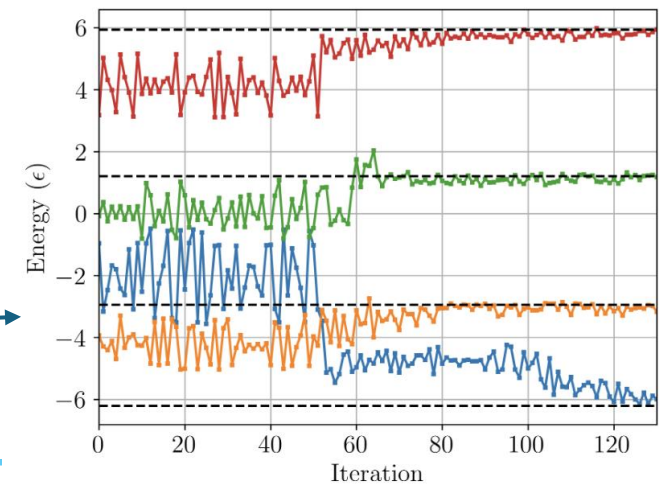

Bhoj and Stevenson, New J Phys **26**, 075001 (2024) quantum circuit to prepare ^{58}Ni state in shell model & variational determination of gate parameters

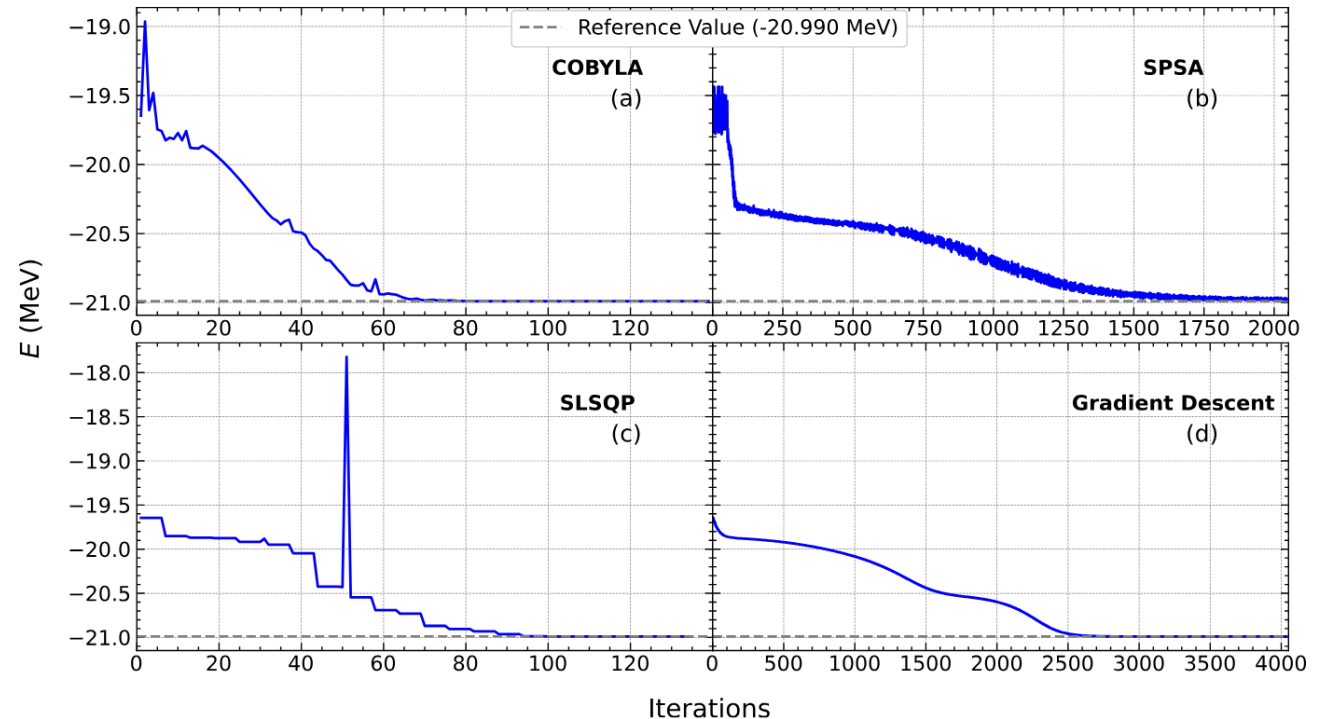
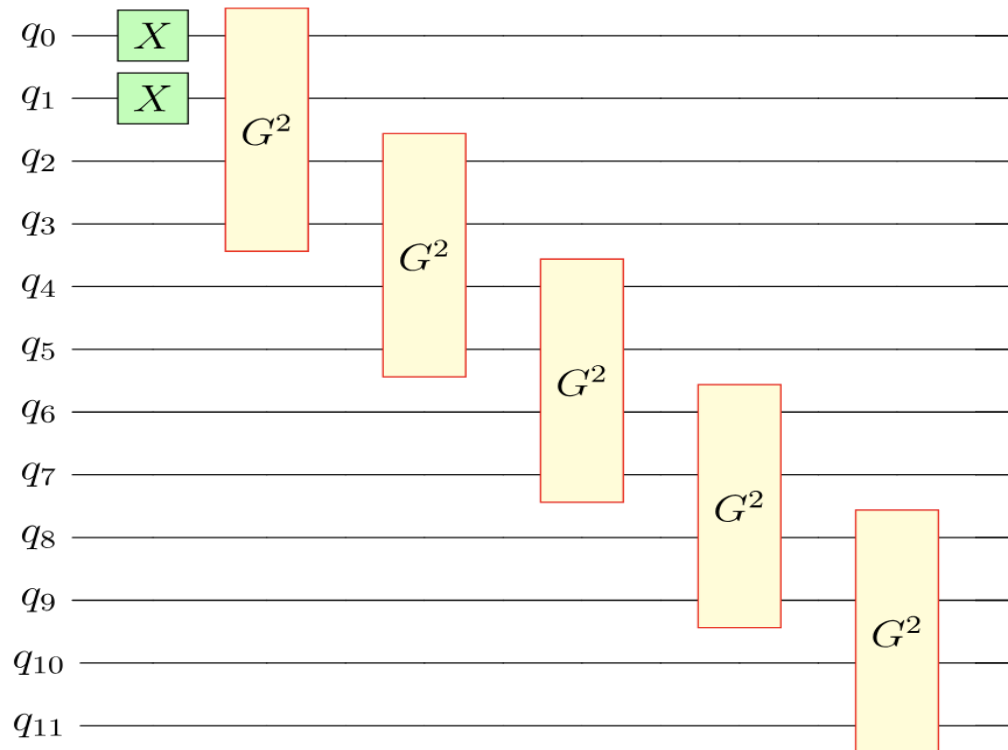

Machine Learning in Nuclear Theory: Yüksel (Surrey), Stevenson (Surrey)

Esra Yüksel, Derya Soydaner and Hüseyin Bahtiyar, [Phys. Rev. C 109, 064322 \(2024\)](#)

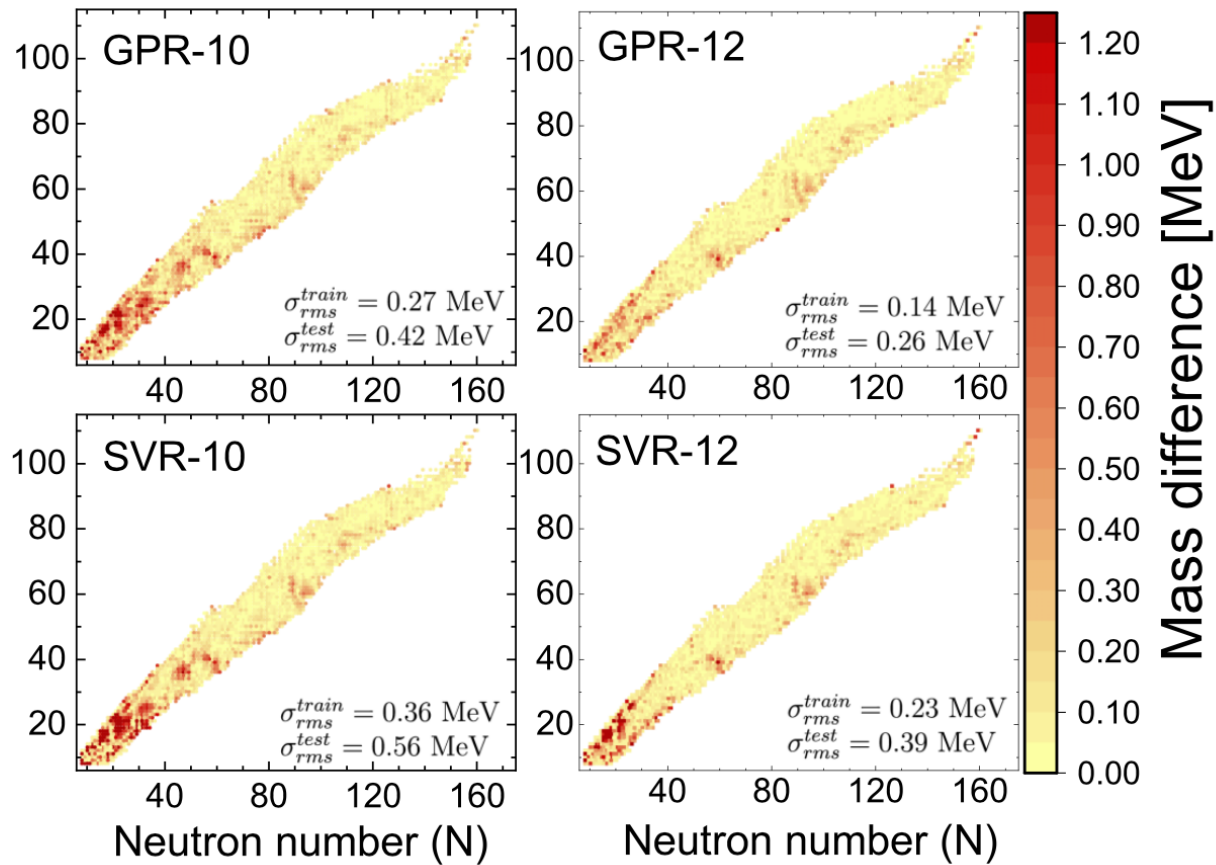

Sullivan, Stevenson, Benstead & Morgan (Surrey / AWE): TALYS neural-network emulator for (n,2n) reaction (Sullivan thesis work, unpublished):

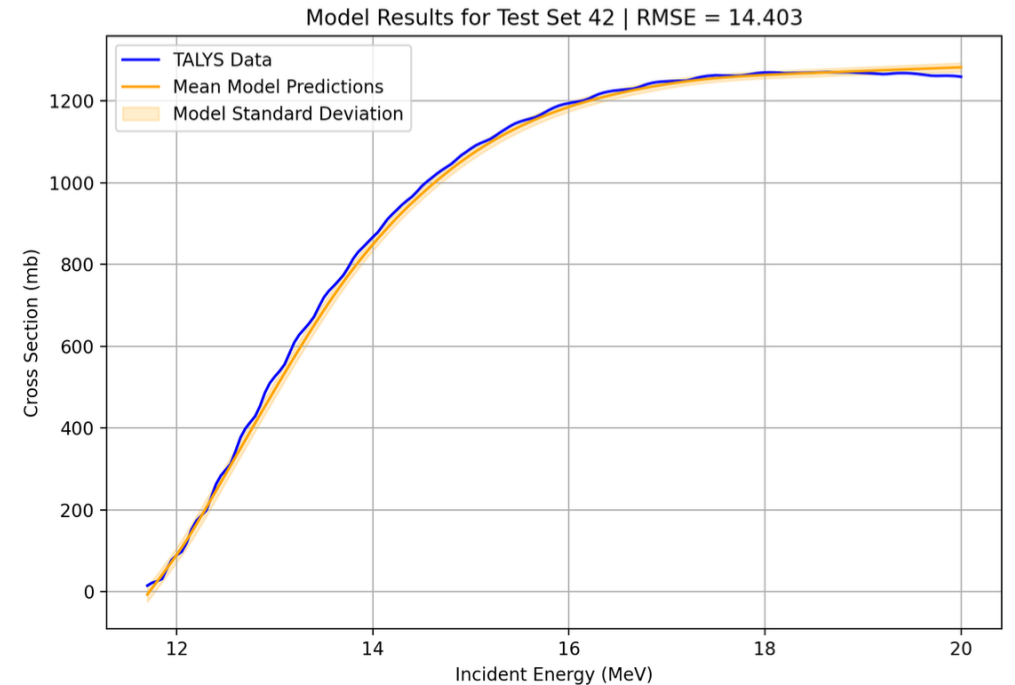

Few-body and hadronic aspects of nuclear physics

McGovern (Manchester)

First ab initio calculations of elastic Compton scattering from ^4He
Uses chiral effective field theory to N³LO

Grißhammer, Liao, McGovern, Nogga, and Phillips
Eur. Phys. J. A 60, 132 (2024)

Bayesian Experimental Design

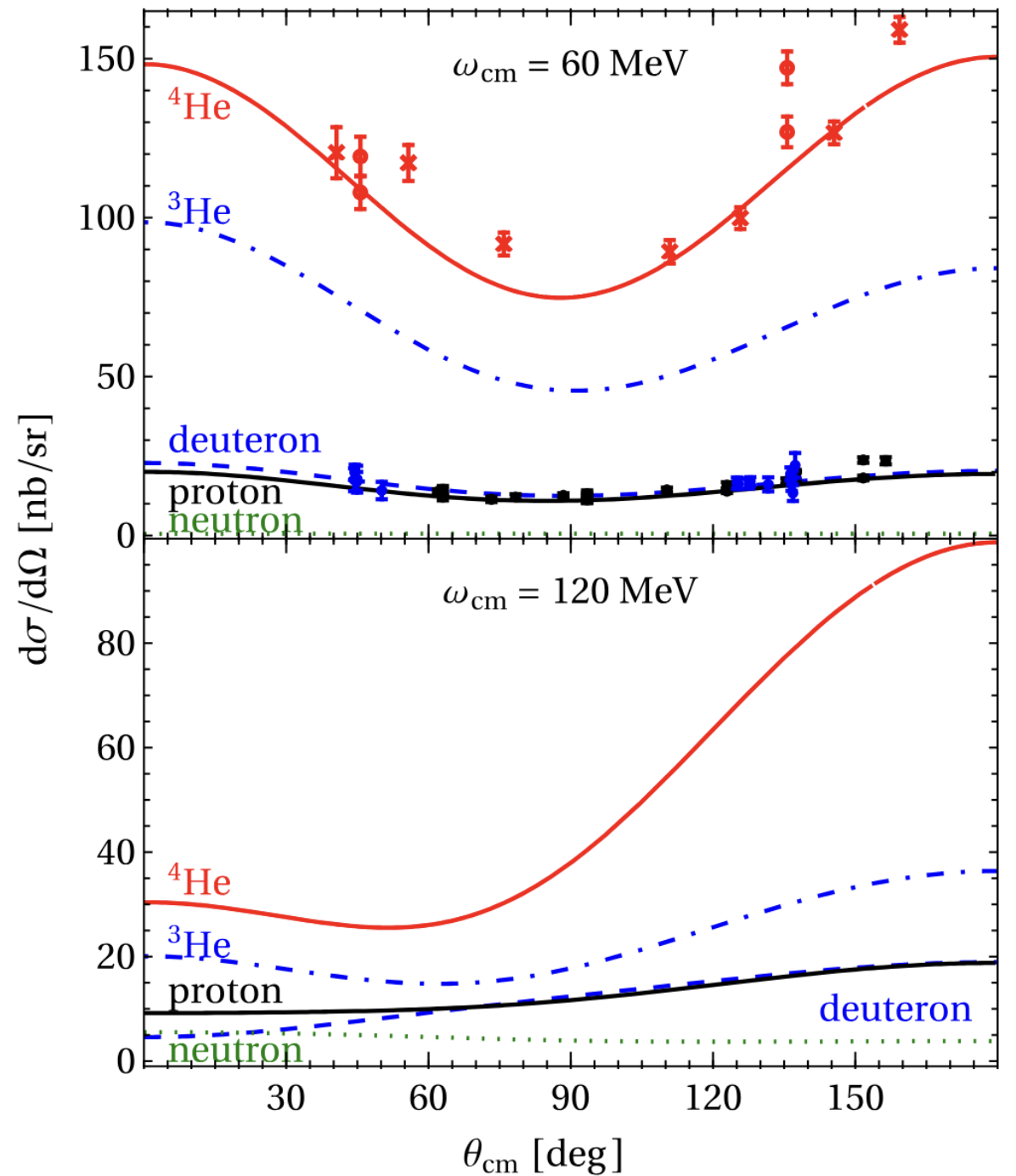
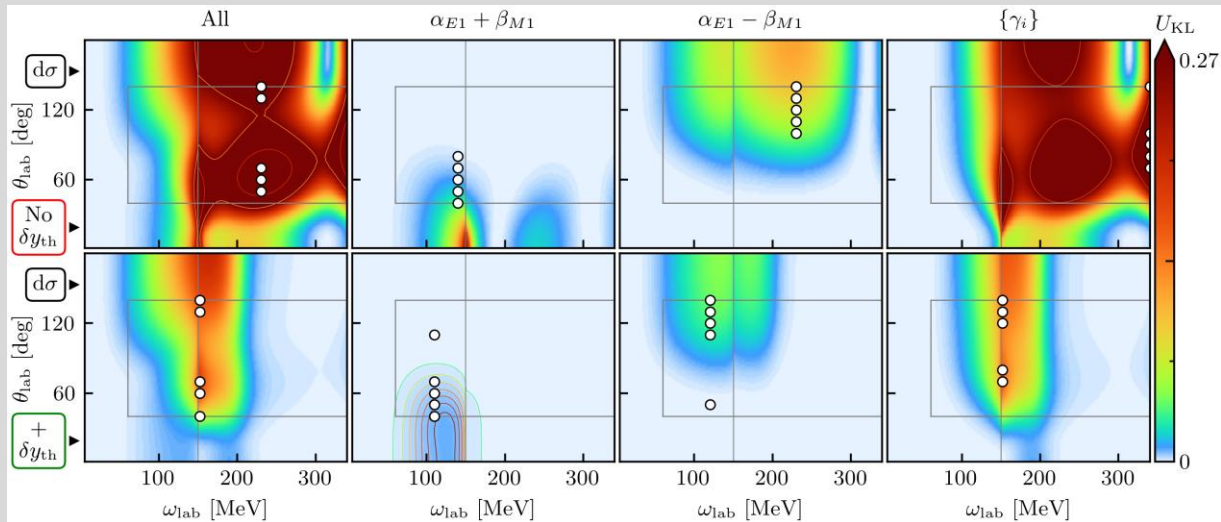

Summary

- UK Nuclear Physics community:
 - Modest size
 - Leadership across several world-leading labs
 - Key roles in several large projects
 - NP Theory active but very small

Some recent research highlights from UK NP

- Improved cross-sections of the deuterium burning $D(p,\gamma)^3\text{He}$ reaction led to BBN estimates of the baryon density at the 1.6 percent level, in excellent agreement with a recent analysis of the cosmic microwave background [Nature 587, 210 \(2020\)](#).
- Measuring correlations in the momentum space between hadron pairs, produced in ultrarelativistic proton–proton collisions at the CERN Large Hadron Collider (LHC), provided a precise method with which to obtain the missing information on the interaction dynamics between any pair of unstable hadrons [Nature 588, 232 \(2020\)](#).
- The spin polarization of the recoiling neutron in deuterium photodisintegration was measured. The results could be related to the excitation of the $d^*(2380)$ hexaquark [Phys. Rev. Lett. 124, 132001 \(2020\)](#).
- High-precision measurements of states above threshold in ^{34}Ar have constrained the astrophysically important $^{33}\text{Cl}(p,\gamma)^{34}\text{Ar}$ reaction, decisive in identifying the origins of pre-solar grains [Phys. Rev. Lett. 124, 252702 \(2020\)](#).
- The first *ab initio* calculations of radii and charge densities for open-shell nuclei beyond Sn have been made, comparing well to experiment and paving the way for *ab initio* studies of exotic charge density distributions at the limit of the present *ab initio* mass domain [Phys. Rev. Lett. 125, 182501 \(2020\)](#).
- The first a-priori lattice QCD calculation showing the presence of a hadron resonance with an exotic combination of spin, parity and charge conjugation quantum numbers [Phys. Rev. D 103, 054502 \(2021\)](#).
- The first mass measurements of neutron-deficient Yb isotopes at TITAN, TRIUMF, established the existence of the N=82 neutron shell up to the proton drip line. Further, the detection and mass measurement of ^{150}Yb marked the first ever discovery of an isotope at TRIUMF [Phys. Rev. Lett. 127, 112501 \(2021\)](#).
- The predicted quantum entanglement in linear polarisation for annihilation gamma photons was proposed as a method to quantify and remove the unwanted backgrounds in Positron Emission Tomography (PET) [Nature Communications 12, 2646 \(2021\)](#).
- Joint mass measurements at TRIUMF and NSCL/FRIB investigate the evolution of the exotic N=32 and 34 neutron shell closures in combination with state of the *ab-initio* calculations [Phys. Rev. Lett. 126, 042501 \(2021\)](#).
- The experiment performed at CEBAF utilized the Large Acceptance Spectrometer (CLAS) detector to study the $\Lambda p \rightarrow \Lambda p$ elastic scattering cross section in the incident Λ momentum range 0.9–2.0 GeV/c [Phys. Rev. Lett. 127, 272302 \(2021\)](#).
- A first ever measurement of timelike Compton scattering which provides a way to test the universality of the generalized parton distributions has been made with the CLAS12 detector at JLab [Phys. Rev. Lett. 127, 262501 \(2021\)](#).
- ALICE confirmed the dead-cone effect and important prediction from perturbative QCD. Careful measurements using charmed quarks as partons show that small angle radiative splittings in jet evolution are suppressed for larger parton masses [Nature 605, 440 \(2022\)](#).
- A recent highlight from the nucleon tomography program at JLab includes a first experimental extraction of all four helicity-conserving Compton form factors (CFFs) of the nucleon as a function of Bjorken x, while systematically including helicity flip amplitudes with extremely high precision. [Phys. Rev. Lett. 128, 252002 \(2022\)](#).
- From the nucleon tomography program at JLab, a first experimental extraction of all four helicity-conserving Compton form factors (CFFs) of the nucleon as a function of Bjorken x with extremely high precision has been performed [Phys. Rev. Lett. 128, 252002 \(2022\)](#), and a first CLAS12 measurement of deeply virtual Compton scattering beam-spin asymmetries in the extended valence region [Phys. Rev. Lett. 130, 211902 \(2023\)](#).
- Measurements performed at the Triangle Universities Nuclear Laboratory were interpreted in the chiral effective field theory framework to extract the electromagnetic dipole polarizabilities of the proton [Phys. Rev. Lett. 128, 132502 \(2022\)](#).
- A resonance-like structure near threshold in the four-neutron system that is consistent with a quasi-bound tetraneutron state existing for a very short time was observed [Nature 606, 678 \(2022\)](#).
- First mass measurements of neutron-rich Cr isotopes established the summit of the N=40 island of inversion [Phys. Lett. B 833, 137288 \(2022\)](#).
- An abrupt change in the nuclear dipole moment at N = 82 was observed. Together with the accompanying theoretical findings, it led to an understanding of how seemingly simple single-particle phenomena naturally emerge from complex interactions among protons and neutrons [Nature 607, 260 \(2022\)](#).
- Recent results from two-nucleon knockout reactions in inclusive elastic electron scattering from hydrogen-3 and helium-3 mirror nuclei have yielded new insights on the pairing up of nucleons inside the nucleus [Nature 609, 41 \(2022\)](#).
- Simultaneous γ -ray and electron spectroscopy demonstrated a step-up in experimental sensitivity and paves the way for systematic studies of electric monopole transitions in this region [Communications Physics 5, 213 \(2022\)](#).
- Nucleon drip lines were determined using several relativistic energy density functionals with different underlying interactions, demonstrating considerable alterations of the neutron drip line with temperature increase, especially near the magic numbers [Nature Comm. 14 4834 \(2023\)](#).
- A new technique for determining fission barriers was demonstrated which will open the way for the study of fission properties with short-lived nuclear species [Phys. Rev. Lett. 130, 202501 \(2023\)](#).
- Direct mass measurements of neutron-deficient nuclides at GSI closing on ^{100}Sn [Phys. Lett. B 839, 137833 \(2023\)](#).
- ALICE measured the hypertriton $\Lambda^3\text{H}$ lifetime and Λ separation energy solving a puzzle as their values previously seemed inconsistent with models of the particle [Phys. Rev. Lett. 131, 102302 \(2023\)](#).
- Measurements of the vibronic structure of radium monofluoride molecules were reported, which demonstrated an improvement in resolution of more than two orders of magnitude compared to the state of the art [Nature Physics 20, 202 \(2024\)](#).
- The calculations using the $^{16}\text{O} + ^{92}\text{Zr}$ collision showed that the inclusion of nuclear friction effects increased the fusion probability significantly, improving the agreement between the theoretical and experimental fusion barrier distributions [Phys. Lett. B 854, 138755 \(2024\)](#).
- First measurement of neutron capture on radioactive ^{204}Tl leads to reduced uncertainty in predicted ^{204}Pb abundance, which is in agreement with solar system observations [Phys. Rev. Lett. 133, 052702 \(2024\)](#).
- The role of the underlying single-particle structure for the Pygmy Dipole Resonance was established [Phys. Rev. Lett. 125, 102503 \(2020\)](#).